



COMBITRAILER CT-411-S





(The picture is not the standard execution)

					
Technische gegevens	Technische Daten	Technical data	CT-411-S	CT-F11-S	CT-R31-S
Geschikt voor	Geeignet für	Suitable for	20 ft 2x 20 ft 40 ft (HC) 45 ft (optional)	20 ft	20 ft
Schoteldruk	Sattellast	Kingpin weight	17.000 kg	17.000 kg	17.000 kg
Max. aslast per as	Max. Achslast pro Achse	Max. Axleload / axle	9.000 kg	9.000 kg	9.000 kg
Tot. toegestane massa	Gesamt zulässige Masse	Gross trailer weight	53.000 kg	26.000 kg	44.000 kg
Leeggewicht	Leergewicht	Empty weight	7.700 kg	3.100 kg	4.500 kg
Nuttig laadvermogen	Nutzlast	Payload	45.300 kg	22.900 kg	39.500 kg
Schotelhoogte	Sattelhöhe	Fifthwheel height	1.110 mm	1.110 mm	1.110 mm
Chassishoogte	Chassishöhe	Chassis height	1.110 mm	1.110 mm	1.110 mm
Bandenmaat	Reifengröße	Tyresize	385/55 R22,5	385/55 R22,5	385/55 R22,5
Electr. Aansluitingen	Elektrische Anschlüsse	Electrical connectors	15 pin only	15 pin only	15 pin only
Stuuras (-sen) op as	Lenkachse (-n) auf Achse	Steeringaxle on axle	1,4	-	3
Liftas (-sen) op as	Liftachse (-n) auf Achse	Liftaxle on axle	1,2,4	-	1,3
Douanestand	Zollstellung	Costoms-position			

OPTIES / OPTIONEN / OPTIONS

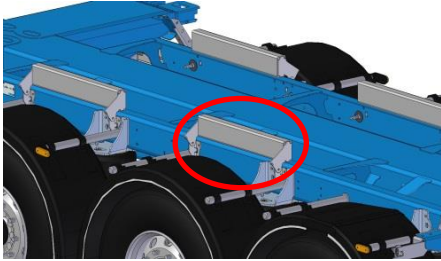
05-17



07-1

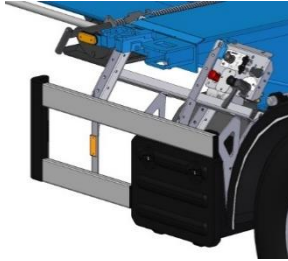

07-2

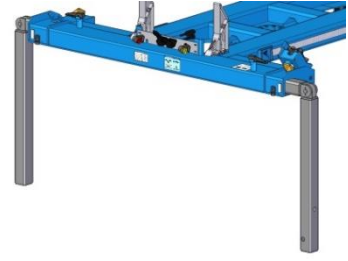

15-14

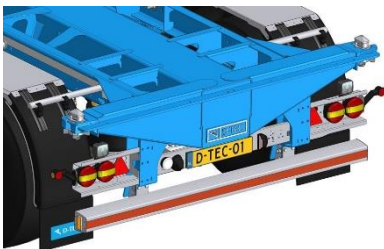

15-15

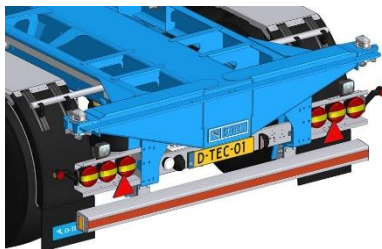

07-NS-39

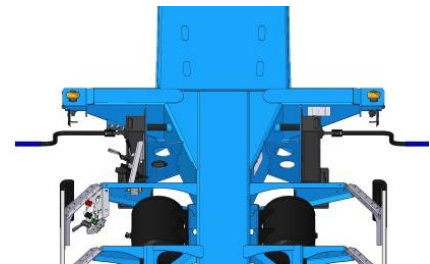

07-NS-12/13/14



07-NS-9

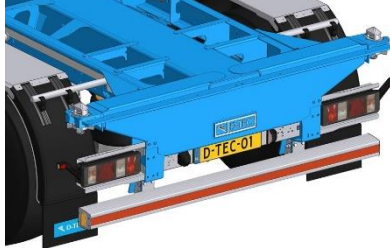

21-3

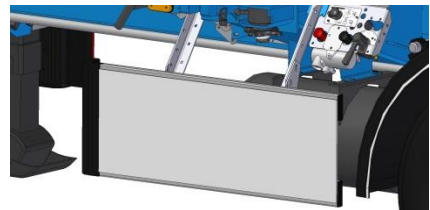

05-9





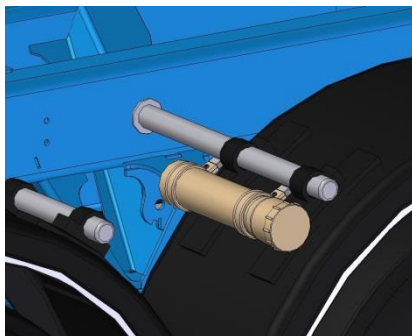



17-7



17-19



 Basis opties		 Basis Optionen		 Basic options	
11-4-15	Valx trommelremmen Standard 2-layer coating in RAL 3002, RAL 5002,	Valx Trommelbremsen RAL 5010, RAL 5015, RAL 7016,		Valx drumbrakes RAL 7021, RAL 9005	
09-1-2	Schooperen bovenzijde	Spritzverzinken Oberseite		Schooping topside	
21-5	Wielkeggen (4x)	Radkeile (4x)		Wheelwedges (4x)	
 Comfort opties		 Komfort Optionen		 Comfort options	
11-NS-15	SAF schijfremmen	SAF Scheiben		SAF discbrakes	
17-8-2	Centrale smering	Zentralschmieranlage		Auto greasing system	
05-9	45 ft positie	45 ft Position		45 ft positie	
13-9	Voeding EBS ook via remlichten	Strom EBS auch über Bremse		Power for EBS by brakelights too	
19-55-65	Voorstuk met 385/55 en achterstuk met 385/65	Vorderteil auf 385/55, Hinterteil mit 385/65		Front part 385/55, Rear part 385/65	
19-65	Bandenmaat 385/65R22,5 Hankook / Continental HTR2	Reifengröße 385/65 R22,5 Goodyear LHT II / GT /		Tyresize 385/65 R22,5 Bridgestone / Michelin	
19-7-5	Alcoa DB	Alcoa DB		Alcoa DB	
19-9-3	Aluminium velgen	Aluminium Felgen		Aluminium rims	
	Reservewiel (staal) met band	Reserverad Stahlfelge		Sparewheel (steel) with tyre	
09-1-1	Schooperen volledig	Spritzverzinken völlig		Schooping full	
	4 of 6 ronde 3-kamer lampen	4 oder 6 runde Rückleuchten		4 or 6 round 3 chamber rear lights	
15-16	Alle lampen in led uitvoering	Komplette Beleuchtung in LED		All lights at the rear in LED	
05-17	Klapkokers ivm geen tunnel	Klappstützen wegen ohne Tunnel		Filling pieces due to no tunnel	
07-1	Kunststof gereedschapskist links	Kunststoff Werkzeugkasten links		Plastic toolbox	
07-2	Steunpoten in de kopbalk	Stützen im Frontbalken		Legs in frontbeam	
07-3	Kingpenslohouder 2x	Halter für Königszapfenverriegelung 2x		Holder for kingpinlock 2x	
07-5	Gevaarlijke stoffen bord	Gefahrgutschild		ADR sign at the rear, orange	
07-28	A-bord 2x	A-Schild 2x		A-sign (waste) 2x	
07-NS-9	Reclameplaat (alleen op achterstuk)	Werbungstafel Stahl (nur am Heckteil)		Steel plate (only at rear part)	
17-19	Reservewieldrager	Reserveradträger		Sparewheelcarrier	
17-22	Antispray achterstuk (385/65)	Anti-spray Hinterteil (385/65)		Anti-spray rearpart (385/65)	
17-7	Documenten koker uit plastic	Dokubox Kunststoff		Document tube	
21-3	Zijbeplating witte trespa	Seitl. Unterfahrschutz Trespa, weiß		Trespa sidefenders, white	
21-8	Kingpinslot	Königszapfenverriegelung		Kingpinlock	
13-8	België: testnippels voor remdrukken	Nür für BE		BE only	
25-NS-2	LZV uitgevoerd en gekeurd	nur für NL		NL only	
17-2	ADR/VLG uitvoering incl certificaten	nur für NL		NL only	
11-18	Multifunctioneel display	Multifunktionales Display		Multifunctional Display	

